

To our valuable consumers

Thank you very much for choosing our e-scooter

This manual focuses on the basic performance, adjustment methods, safe driving instructions and maintenance information of electric scooters. For your own safety and more enjoyable riding experience, please carefully read the contents of this manual before riding the electric scooters. Your riding safety depends not only on your personal alertness and your driving proficiency, but also depends on the mechanical performance of the electric scooters. It is essential that you check and perform maintenance for the electric scooter before riding every single time.

This electric scooter will be your ideal transportation tool as long as you check in advance, master the safe driving method and obey the traffic rules. Due to the continuous improvement of this product, the relevant data and structure of this manual are subject to change without further notice.

Kind reminder:

Please do not use the electric scooter without carefully reading the instructions and understanding the function of electric vehicle. Please do not lend it to people who do not know how to operate and ride the electric vehicle.

Please do not discard the waste battery at will to avoid polluting the environment. The waste battery of our product shall be recycled by our company, our dealers or outlets designated by the government.

Content

Vehicle configuration list.....	01
Complete vehicle structure drawing.....	02
keyhole.....	03-04
Console.....	04
Switch comp.....	05
Tail light.....	06
Quick installation.....	06
Assembly and adjustment of main parts.....	07-08
Battery service environment.....	09
Correct use of charger.....	10
Battery maintenance.....	11
Vehicle body maintenance.....	12
Important notes.....	13-14
Inspection before riding.....	15
Common faults and troubleshooting.....	16
Non-warranty clause.....	17
Correct use of vehicle.....	18

Vehicle configuration list

No.	Name	Unit	Qty.	Remarks
1	electric scooter	unit	1	
2	key	set	2	
3	charger	pcs	1	
4	instruction book	pcs	1	
5	rear view mirror	pair	1	



Once the purchased product is used, it shall be deemed that the user agrees that the product's configuration is complete and intact, other free configuration request from customers will no longer be accepted. Our company provides a variety of promotional items but they shall be not deemed as normal and on-board configuration.

Complete vehicle structure drawing

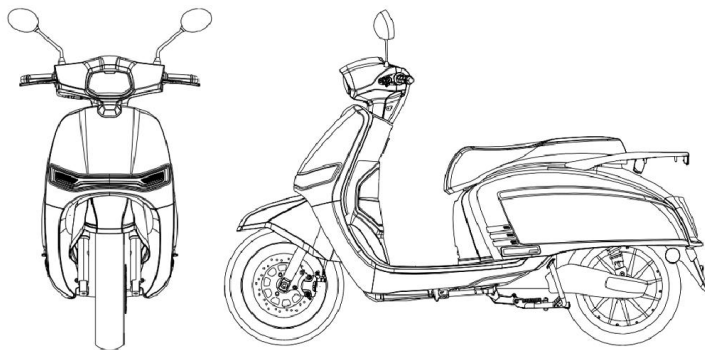

Model parameters chart ►

Version	Lithium L1E	Lithium L3E
Battery type	72V 55AH	72V 55AH
Charging time	2.5 H	2.5H
Motor	3000W hub motor	3500W side motor
Brake system	F/R Disc brake	F/R CBS Disc brake
Tyre	120-70-120	120-70-120 tire
Max speed	45km/h	80km/h
Max range	100km	80km

Keyhole

It can achieve "keyless start", but you still need to have the key.



LOCK

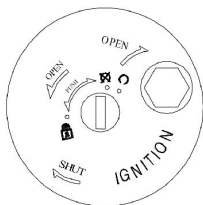

OFF position

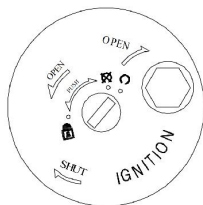

ON position

Console

It adopts intelligent operation console, the display mode is the same as that of conventional household scooter including battery electricity capacity, current speed, odometer&trip meter, direction signal light indication, parking indication, riding mode indication.

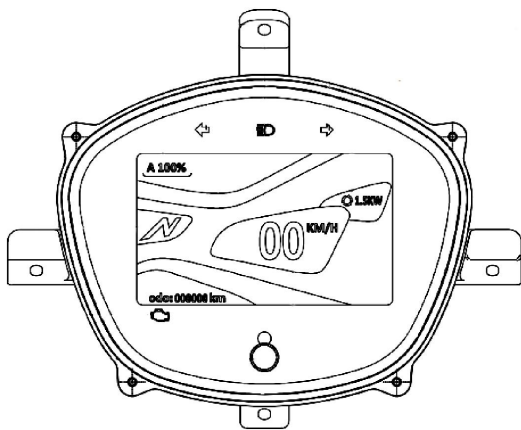

Instruction for battery level indicator light

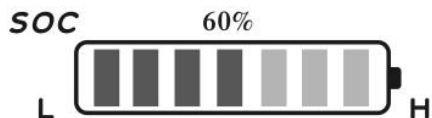

The battery level is displayed by the percentage energy bar in the battery icon in the display. When there is only 30% battery bar remaining, please charge the vehicle as soon as possible.

Switch comp

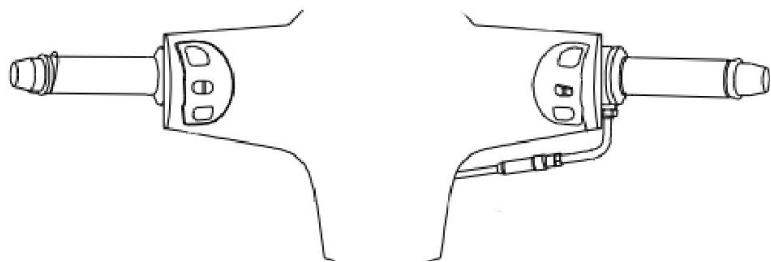

Left hand switch comp includes: High&low beam light switch, turning light switch, horn button,.

Right hand switch comp includes: warning light switch, riding mode button.

Tail light

The rated voltage of vehicle tail light is 12V (which can be changed), and the spotlight effect is outstanding which can help you ride at night freely.

Tail light schematic for scooter

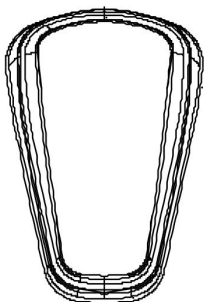

Quick installation

You can start to travel comfortably with simple installation steps.

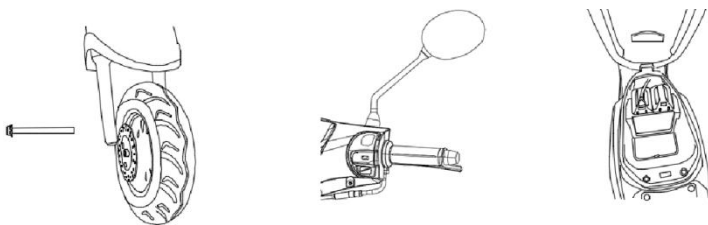

①Front wheel installation ②Rear-view mirror installation ③Connect the power cord

Vehicle items

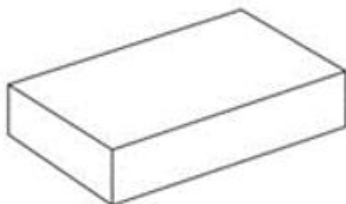
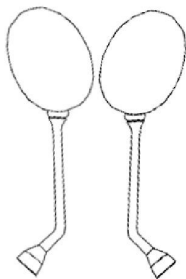

Tool box including(manual, charger, rear-view mirror.)

Assembly and adjustment of main components

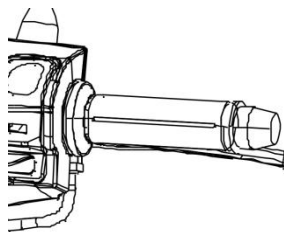
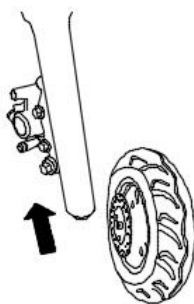

1. Front & rear wheel installation and adjustment of scooter : When installing the front wheel, the front wheel sleeve should be inserted into the front fork tab. For the safety lever, it should be set on the

front axle and fastened at the square hole of the front fork tab; The drive motor shall be installed before installing the rear wheel.

2. Electric brake adjustment: When the brake is grasped at 1/2 the distance of the brake lever, the brake can work safely. After the brake is released, the brake lever can immediately return to the original position.

3. Cantilever brake adjustment of scooter: adjust the nut when loosening the brake shoe, so that the brake shoe can contact the gravity center of the rim in parallel, the lateral side should be opposite to the rim and then tighten the brake shoe adjustment nut; When tightening the loose rope nut, remove the hanging brake steel rope from the bridge, then adjust the distance between the brake shoe and the rim for 2-3mm, and adjust the hanging brake steel rope to the appropriate length(In the non-braking state, the rope should not touch the mud plate),and finally tighten the tight rope nut. Loosen the bridge nut, hang the hanging rope on the bridge, adjust the brake rope to the appropriate length, tighten the bridge nut, hang the hanging brake steel rope on the bridge, adjust the brake rope to the appropriate length, and then tighten the bridge nut. Under the non-braking state, if the brake shoe cannot be reset to original position and still touch the rim, the connecting bolt should be loosened or the lubricating oil should be applied here to ensure the free rotation of the torsion spring. It is forbidden to apply oil on the rim friction part. Adjust the front wheel drum brakes and the front bolts to minimize the distance between the brake disc and the brake

shoe without interference.

Battery service environment

There are two kinds of battery: lithium battery or lead-acid battery, lithium batteries are small in size, light in weight, long in service life, easy to take out and charge.

Meanwhile, please pay attention to the following issues when using the vehicle:



If the battery has peculiar smell, abnormal heating and deformation, please stop using immediately and keep away from the battery.

Battery charging environment

1. Please charge the scooter when the environmental temperature is 0°C-45°C.
2. Please place the charger in a safe place that children cannot reach when charging.
3. In order to avoid affecting the service life of the battery, do not charge for more than 12 hours.
4. If the battery is not fully charged for continuous 12 hours, please stop charging.
5. In order to ensure good battery life and superior performance,

please ride when the battery level is between 20% -90%.

6. If you need to lay the scooter aside for a long time, please make sure that the storage environment is between 0 °C - 30 °C and the battery store above 50%. At least one month. Please charge and discharge the scooter battery completely once in a month at least, otherwise the battery will experience a irreversible power decay.

7. Avoid storing the battery in the place where there is a risk of falling, because it may cause the risk of leakage, abnormal heating, smoke, even fire and other hazard.

Correct use of charger

Please charge as shown in the figure .

When the input & output terminals of the charger are connected, the red indicator light of the charger will be on: The standard charging time should be: Charge according to the time specified by the matching charger.

Note: When charging for the first time, the battery shall be fully charged before use; Do not disassemble the charger without permission because it contains high voltage circuit; When charging the battery, do not cover anything on it to avoid accidents.

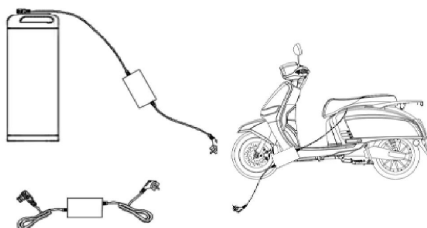

Battery maintenance



In order to achieve the best performance, please maintain the battery according to the instructions.

Specific requirements are as follows:

1. Charging time should not be too long or too short. After the charging process appears to finish, try to keep it for a while and disconnect the power supply to ensure the battery is fully charged.
2. Battery storage with low power is strictly prohibited.
3. Exposure in high temperature or rainy environment will lead to an irreversible impact on battery life. Therefore, the battery of this product should avoid the above conditions.
4. In order to avoid the occurrence of large current discharge, please pay attention to slowly adjust the speed handle when you riding

Capacity drops by 1% if the temperature drops by 1°C. When battery is under high temperature in winter, the battery cycle capacity is weak and the electrolyte viscosity increases, so the chemical reaction resistance increases and the charging time may be shortened (70% will be charged below 5°C)

The charging capacity is 60%~70%, the discharge is 50%~60%, and the mileage will be reduced (namely the scooter cannot run long distance).

It is strictly forbidden to charge electric scooters in an environment below 0°C!

Usage and maintenance of wheel hub

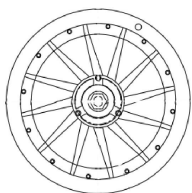

1. When using the scooter, please pay attention to check the tightening state of the electric wheel hub mounted on the rear fork. If the nut is found loose, then tighten the nut in time or ask the professional for help.
2. When the water depth of the rainy road exceeds the center of the electric wheel hub, it may cause motor failure. Therefore, please pay attention to dry the motor wheel hub and motor after riding in rainy days.
3. When you riding , the electric hub should not be subjected to strong impact. Meanwhile, the scooter should not be forced to start in a blocked state. If the product cannot be started due to being blocked, do not start the motor repeatedly until the blocked state is relieved.

Scooter Body maintenance

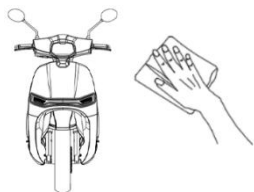

Although the scooter has good waterproof performance, in order to achieve the best riding state, please avoid direct rain or exposure to insolation to prevent scooter body or rotating components from rusting.

If direct contact of the rain cannot be avoided, be sure to wipe the scooter body clean after riding so that the rusting can be prevented and the riding performance will not be affected.

Electronic control system usage precautions



The electronic control system is the core of the scooter electric system and has protective functions such as under voltage, current limit and self-test. As the main circuit of an electric vehicle, the electronic control system has a large current and emits heat when working. Therefore, the electric vehicle should not be parked under the sunlight or near a heat source, so as to avoid the malfunction of the controller and affect the normal use of this product.

Important notes

1. Develop a good charging habit. Make sure the energy of scooter is above the minimum allowable riding level before each riding.
2. As an important part of the scooter, the battery is affected by various external factors. Generally speaking, the discharge performance of the battery is good when the temperature is high. But the power of the battery may drop by more than 1/3 if the temperature drops below 0°C. Therefore, when the cold winter arrives, the reduction of the cruising range after one-time charging is quite normal. When the temperature rises above 25°C, its function will naturally recover.
3. It is forbidden to use a charger that does not match the scooter (or

not provided by our company) for charging. Our company shall not be liable for any accident arising out of this.

4. Minors, pregnant women and the elderly should be extremely cautious when riding electric bicycles.

5. When riding downhill, be sure to use the front brake first to avoid accidental injury caused by the forward movement of the center of weight.

6. Before riding, please make sure that the brakes, cushions, body, handlebars, tires are safe and reliable to avoid accidents.

7. Please avoid riding in muddy, bumpy and stairs roads to avoid accidental puncture, wheel hub deformation and damage to your electric vehicle.

8. Please do not hang heavy objects on the handlebars to avoid runaway.

9. It is strictly forbidden to short the positive & negative poles of the battery with wires or conductors to avoid danger and damage to the battery.

10. Handle the battery gently to avoid collision and damage to the battery.

Inspections before riding



Expects you to do a thorough inspection before riding in order to ensure your driving safety:

1. Whether the tire pressure is normal.
2. Whether the front & rear hubs are locked, the tightening torque of the front wheel tightening nut is not less than 19.6Nm, while that of the rear wheel nut is not less than 30Nm.
3. The brakes should be reliable and can reset flexibly. The braking distance should be increased in rainy and snowy days.

Instructions for use

1. Insert the key into the keyhole and turn it to the“ON” position so the battery indicator light will be on, indicating that the power is on.
2. Turn the speed control knob(right handle) inward (counter clock wise). When the vehicle is starting , the turning angle of the speed control handle changes from small to large, so the vehicle speed changes from slow to fast as well.
3. At the beginning of starting up, it should be slowly accelerated to avoid excessive rapid start up current and waste of electrical energy.
4. Rider should choose constant speed during the riding process and minimize frequent braking and starting for the sake of safety .

Common faults and troubleshooting

Fault phenomenon	Fault diagnosis	Troubleshooting
The console indicator is not on The motor won't operate	Battery voltage under normal voltage	Charging immediately
	Battery life exhausted	Replace the battery
	Power lock damaged	Replace the power lock
High-speed operation of the motor cannot be controlled after the power lock is turned on	Original parts in the controller damaged	Replace the controller
Motor runs & stops randomly	Poor battery contact	Adjust or polish contacts
	Power lock burned down	Replace the power lock
Short distance ride after one time charging	End of battery life	Replace the battery
	Battery life mismatch	Replace the charger
Battery cannot be (fully)charged	End of battery life	Replace the battery
	Charger no output	Replace the charger
	Poor contact between charger and charging socket	Replace the charging socket
Headlight is not bright	Headlight switch damaged	Replace the switch
Controller component burned out	Water in the controller, short circuit, etc	Replace the controller

Non-warranty clause

1. Exceeding the “Product warranty” period (excluding maintenance or repair time due to company reasons).
2. Damage caused by improper usage, such as: crash, falling, overload, overspeed and failure caused by not driving according to electric vehicle driving instructions.
3. Damage caused by smoke, drugs, chemicals and failures caused by force majeure such as earthquakes, typhoons, floods, fires, etc.
4. Phenomenon that does not affect the feeling of normal driving or performance to a certain extent, such as: shock vehicle, noise, etc.
5. Unauthorized disassembling or damage of the vehicle component.
6. Damage to the charger, battery and motor due to violating using instructions.
7. Unauthorized use of non-original vehicle accessories and cause damage to components, such as: installation of non-original vehicle basket, rear shelf and the vehicle is damaged due to being stuck during driving.
8. Change the "Product warranty" certificate or the product model and motor number are inconsistent with the “ Product warranty ” certificate.
9. Damage to components due to human factors.
10. Use the charger on another brand vehicle without permission, causing the charger to be damaged by the circuit back.
11. If the original state is damaged, product warranty shall not be performed.

Correct use of vehicle

1. Please read this product manual carefully and ride the scooter safely to enjoy a comfortable trip.
2. Please obey the relevant traffic regulations, refuse to go retrograde, run red lights or make other illegal acts. Do not use mobile phones or wear headphones while riding to avoid potential safety hazards;
3. Please do not use third-party accessories that are not official scooter standard. Do not disassemble, crack and modify the scooter without authorization. Otherwise, the damage caused will be borne by you and you will lose the scooter electric warranty.

It is forbidden to wear headphones and use mobile phones while driving !